

# ACCESSOIRES UNIVERSELS

V3.21

[www.hobifrance.com](http://www.hobifrance.com)



- SILENCIEUX Euro 0-1-2-3
- SILENCIEUX CATALYTIQUE Euro 4-5-6
- TUBES
- FLEXIBLES
- ACCESSOIRES

**hobi**®

ÉCHAPPEMENTS PL  
RÉSEROIRS D'AIR PL  
RÉSEROIRS DE CARBURANT PL

# SOMMAIRE

|   |    |
|---|----|
| COLLIERS « TORCA » , « FLEX » , « FILS » .....                | 3  |
| COLLIERS « PLATS » , « VOLVO » .....                          | 4  |
| COLLIERS « IVECO - MERCEDES » , CLAPETS ANTI PLUIE .....      | 5  |
| BRIDES « M8 » , « BRIDES « M10 » , SUPPORTS de BRIDES .....   | 6  |
| COLLIERS en « V » , « SCANIA » , Embouts 42180 à souder ..... | 7  |
| COUDES à 90° et 45° MÂLE - MÂLE ou MÂLE - FEMELLE.....        | 8  |
| TUBES DROITS MÂLE - MÂLE, TUBES FLEXIBLES 2 mètres .....      | 9  |
| TUBES FLEXIBLES 1 mètre, TUBES DROITS MÂLE - FEMELLE.....     | 10 |
| TUBES COUDES - MANCHONS D'ACCOUPEMENTS.....                   | 11 |
| CAOUTCHOUCS DE SUSPENSION .....                               | 12 |
| PARE FLAMMES « PL » et « VL » .....                           | 13 |
| SILENCIEUX STANDARDS - BANDE THERMIQUE .....                  | 14 |
| RACCORDS 90° - PARE-CHALEUR TUBES - SANGLES SILENCIEUX .....  | 15 |



## COLLIERS « TORCA »

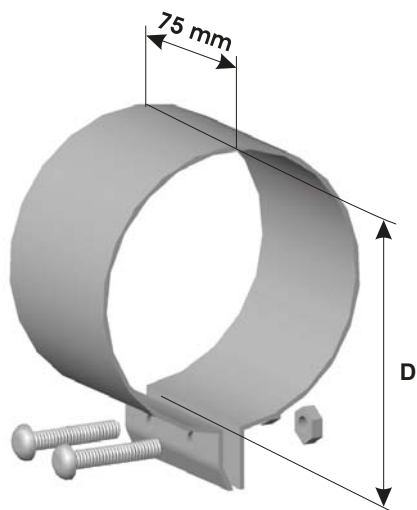

| Électrozingués | Inox 304 L | Diamètres (mm) |  |
|----------------|------------|----------------|--|
| Réf. HOBI      | Réf. HOBI  | Dia. (mm)      |  |
| 11739          | 11739T     | 50             |  |
| 11630          | 11630T     | 57             |  |
| 11646          | 11646T     | 63,5           |  |
| 11609          | 11609T     | 70             |  |
| 11604          | 11604T     | 76,2           |  |
| 11651          | 11651T     | 88,9           |  |
| 11297          | 11297T     | 101,6          |  |
| 11295          | 11295T     | 108            |  |
| 11282          | 11282T     | 114,3          |  |
| 11270          | 11270T     | 127            |  |
| 11275          | 11275T     | 138            |  |
| 11233          | 11233T     | 152            |  |

## COLLIERS « FLEX »

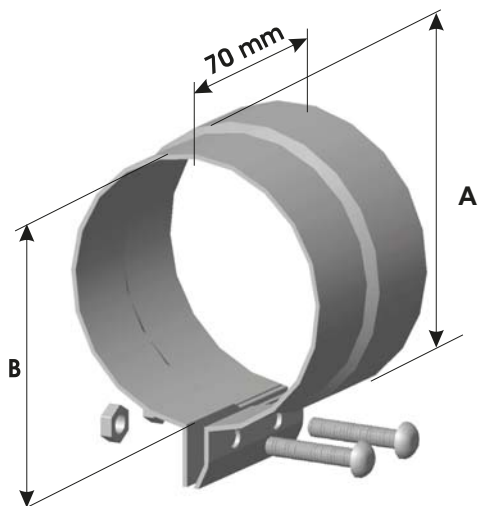

| Électrozingués | Inox 304 L | Diamètres (mm) |          |
|----------------|------------|----------------|----------|
| Réf. HOBI      | Réf. HOBI  | Dia. "A"       | Dia. "B" |
| 11783          | 11783T     | 55             | 50       |
| 11735          | 11735T     | 62             | 57       |
| 11748          | 11748T     | 65             | 60       |
| 11741          | 11741T     | 75             | 70       |
| 11700          | 11700T     | 81,2           | 76,2     |
| 11758          | 11758T     | 84             | 80       |
| 11719-11751    | 11719T     | 93,6           | 88,9     |
| 11698          | 11698T     | 105            | 100      |
| 11696          | 11696T     | 106,6          | 102,6    |
| 11695          | 11695T     | 108,0          | 113,0    |
| 11688-11689    | 11688T     | 115            | 110      |
| 11683-59508    | 11683T     | 119            | 114,3    |
| 11678          | 11678T     | 125            | 120      |
| 11670-11675    | 11675T     | 132            | 128      |
| 11639          | 11639T     | 158            | 152      |

## COLLIERS « FILS »

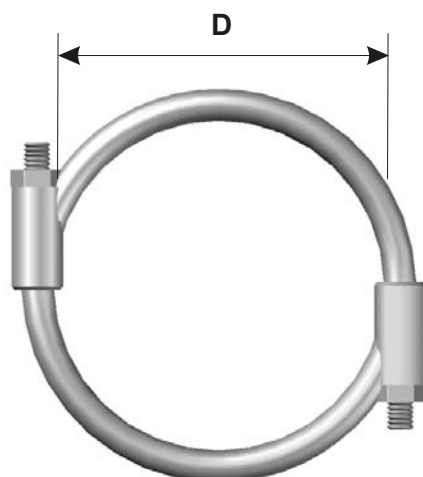

| Électrozingués |           |
|----------------|-----------|
| Réf. HOBI      | Dia. (mm) |
| 11957          | 76 - 82   |
| 11912          | 83 - 94   |
| 11890          | 95 - 107  |
| 11882          | 108 - 114 |
| 11881          | 115 - 119 |
| 11867          | 120 - 132 |
| 11832          | 142 - 154 |

## COLLIERS « PLATS »

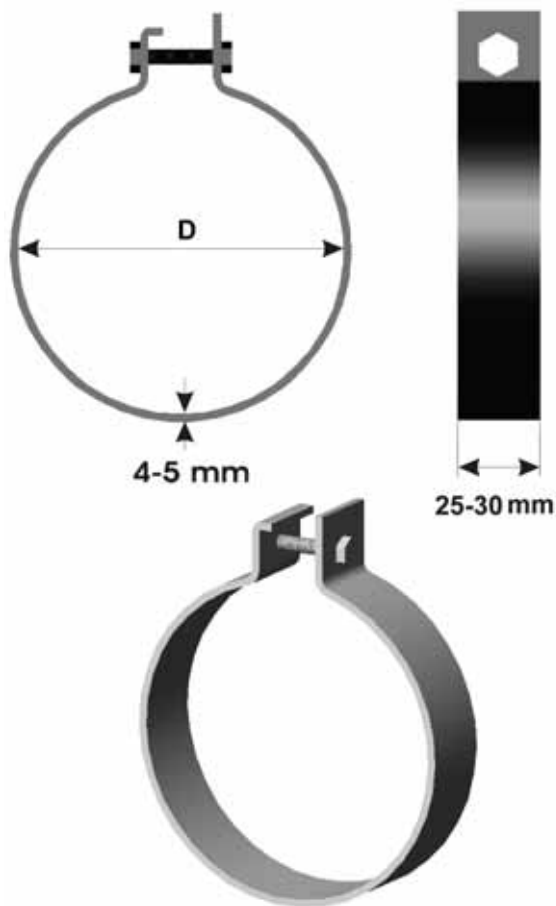

### Électrozingués

| Réf. HOBI | Dia. (mm) |
|-----------|-----------|
| 11023     | 45,5      |
| 11025     | 48,5      |
| 11039     | 50,5      |
| 11036     | 53,5      |
| 11033     | 55,5      |
| 11035     | 58,5      |
| 11049     | 60,5      |
| 11046     | 63,5      |
| 11043     | 65,5      |
| 11045     | 68,5      |
| 11009     | 70,5      |
| 11006     | 73,5      |
| 11003     | 75,5      |
| 11004     | 76,5      |
| 11005     | 78,5      |
| 11059     | 80,5      |
| 11053     | 85,5      |
| 11051     | 90,5      |
| 11012     | 94,5      |
| 11099     | 100,5     |
| 11097     | 102,5     |
| 11092     | 104,5     |
| 11095     | 108,5     |
| 11089     | 110,5     |
| 11082     | 114,5     |
| 11079     | 120,5     |
| 11072     | 124,5     |
| 11070     | 127,5     |
| 11069     | 130,5     |

## COLLIERS « VOLVO »

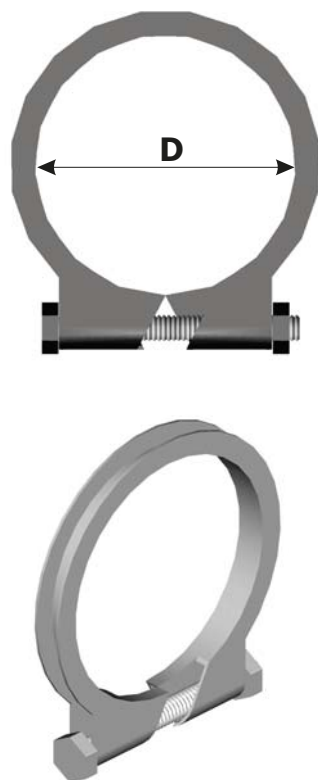

### Électrozingués

| Réf. HOBI     | Dia. (mm) |
|---------------|-----------|
| 11922         | 29 - 32   |
| 11924         | 32 - 35   |
| 11926         | 35 - 38   |
| 11927         | 39 - 42   |
| 11923         | 42 - 45   |
| 11925         | 45 - 48   |
| 11938         | 48 - 51   |
| 11933         | 52 - 55   |
| 11935         | 55 - 58   |
| 11948         | 58 - 61   |
| 11942         | 61 - 64   |
| 11940         | 65 - 67   |
| 11908         | 68 - 71   |
| 11902         | 71 - 74   |
| 11900         | 74 - 77   |
| 11956         | 78 - 82   |
| 11950         | 83 - 87   |
| 11914 - 42559 | 91 - 96   |
| 11899         | 100 - 106 |
| 11895         | 104 - 107 |
| 11883         | 108 - 114 |
| 11879         | 115 - 120 |
| 11870         | 123 - 128 |
| 11863         | 130 - 135 |
| 11820         | 142 - 147 |
| 11831         | 151 - 159 |

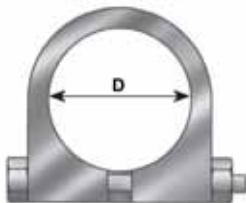

## COLLIERS « IVECO - MERCEDES »

| Design A<br> | Électrozingués |             |        |
|---|----------------|-------------|--------|
|   | Réf. HOBI      | Dia. (mm)   | Design |
|   | 75589          | 59,5 - 62,5 | A      |
|   | 75558          | 63 - 66     | A      |
|   | 75588          | 65 - 68     | A      |
|   | 75559          | 67 - 70     | A      |
|   | 39174          | 74 - 77     | A      |
|   | 39123          | 76 - 79     | A      |
|   | 75536          | 80 - 83     | A      |
|   | 39170          | 87,5 - 90,5 | A      |
|   | 39172          | 92 - 96     | A      |
|   | 75535          | 97 - 100    | A      |
|   | 75506          | 102 - 105   | B      |
|   | 75534          | 104 - 107   | A      |
|   | 75502          | 106 - 110   | B      |
|   | 75543          | 114 - 118   | B      |
|   | 75544          | 118 - 122   | B      |
|   | 75503          | 128 - 132   | B      |
|   | 75504          | 131 - 135   | B      |
|   | 75575          | 146 - 151   | B      |

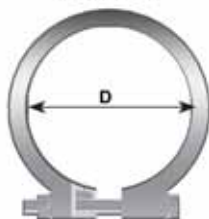
Design B



## CLAPETS ANTI PLUIE

|  | Électrozingués |           |  | Électrozingués |           |
|---|----------------|-----------|--|----------------|-----------|
|   | Réf. HOBI      | Dia. (mm) |  | Réf. HOBI      | Dia. (mm) |
|   | 15980          | 170       |  | 15239          | 50,5      |
|   | 15981          | 193       |  | 15249          | 60,5      |
|   | 15982          | 200       |  | 15242          | 63,5      |
|   | 15983          | 219       |  | 15211          | 65,5      |
|   | 15984          | 250       |  | 15209          | 70,5      |
|   | 15985          | 300       |  | 15204          | 76,5      |
|   | 15986          | 323       |  | 15259          | 80,5      |
|   | 15987          | 350       |  | 15251          | 90,5      |
|   | 15988          | 400       |  | 15299          | 100,5     |
|   |                |           |  | 15297          | 102,5     |
|   |                |           |  | 15289          | 110,5     |
|   |                |           |  | 15282          | 115,5     |
|   |                |           |  | 15279          | 120,5     |
|   |                |           |  | 15270          | 127,5     |
|   |                |           |  | 15229          | 140,5     |
|   |                |           |  | 15238          | 152,5     |
|   |                |           |  | 15245          | 160 - 168 |
|   |                |           |  | 15296          | 203,5     |

Livrés électrozingués recouverts de peinture noire. Fabrication INOX possible.

## EXEMPLES DE MONTAGES

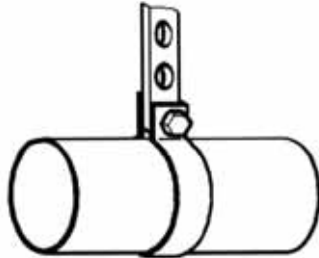
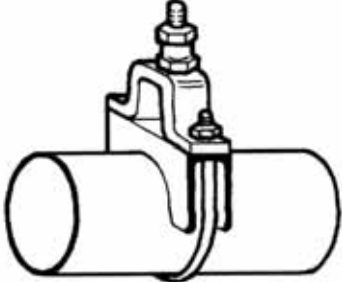
| FIXER UN FLEXIBLE SUR UN TUBE   | SUSPENDRE UN TUBE   | FIXER UN TUBE SUR UN CHÂSSIS   |
|---|---|--|
|  |  |  |
| Utiliser les colliers « VOLVO », ils ne cassent pas les spires du flexible.         | Utiliser les colliers « PLATS »   | UTILISER LES « BRIDES »<br>+ « SUPPORTS DE BRIDES »<br>+ « CAOUTCHOUCS »             |

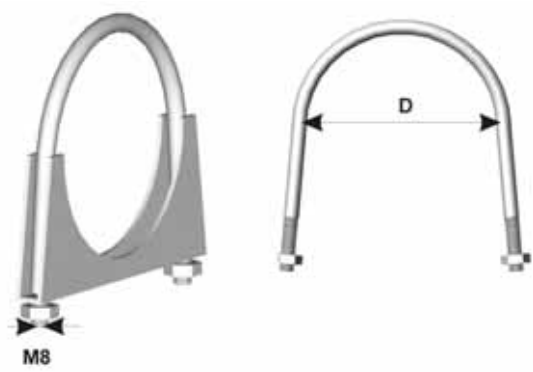

## BRIDES « M8 »

|   |       | Électrozingués |           |           |           |
|---|-------|----------------|-----------|-----------|-----------|
|   |       | Réf. HOBI      | Dia. (mm) | Réf. HOBI | Dia. (mm) |
|  | 19975 | 29             | 19909     | 70        |           |
|   | 19967 | 32             | 19906     | 73        |           |
|   | 19963 | 37             | 19904     | 76,2      |           |
|   | 19965 | 38             | 19901     | 80        |           |
|   | 19928 | 44             | 19956     | 83        |           |
|   | 19923 | 45             | 19951     | 88,9      |           |
|   | 19925 | 48             | 19917     | 92        |           |
|   | 19937 | 52             | 19913     | 95,3      |           |
|   | 19932 | 54             | 19897     | 102       |           |
|   | 19930 | 57             | 19894     | 105       |           |
|   | 19949 | 60             | 19882     | 114       |           |
|   | 19942 | 65             | 19870     | 127       |           |
|   | 19940 | 67             | 19871     | 130       |           |

## BRIDES « M10 »

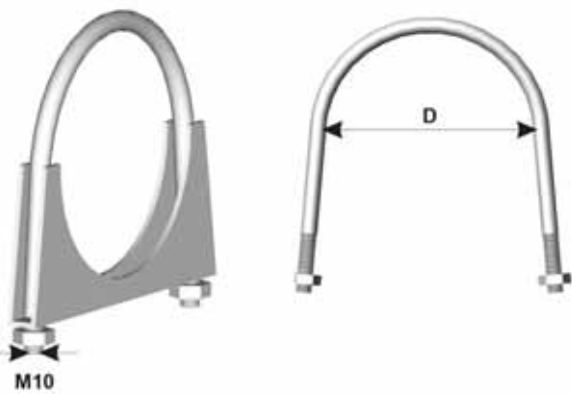
|   |       | Électrozingués |           |
|---|-------|----------------|-----------|
|   |       | Réf. HOBI      | Dia. (mm) |
|  | 19893 | 105            |           |
|   | 19891 | 109            |           |
|   | 19889 | 110            |           |
|   | 19879 | 120            |           |
|   | 19869 | 130            |           |
|   | 19827 | 142            |           |
|   | 19833 | 155            |           |
|   | 19843 | 165            |           |

## SUPPORTS DE « BRIDES »

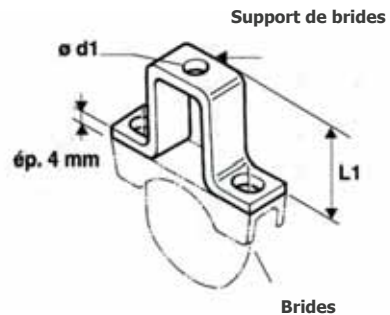
|   |       | Électrozingués               |                     |            |            |
|---|-------|------------------------------|---------------------|------------|------------|
|   |       | Pour Tubes<br>Dia. Ext. (mm) | Réf. HOBI<br>Brides | D1<br>(mm) | L1<br>(mm) |
|  | 50    | 19937                        | 12                  | 49         | 19997      |
|   | 60    | 19949                        | 12                  | 49         | 19997      |
|   | 65    | 19942                        | 12                  | 49         | 19997      |
|   | 70    | 19909                        | 12                  | 49         | 19998      |
|   | 75    | 19904                        | 12                  | 64         | 19998      |
|   | 80    | 19901                        | 12                  | 64         | 19998      |
|   | 88,9  | 19951                        | 12                  | 64         | 19998      |
|   | 101,6 | 19897                        | 14                  | 74         | 19999      |
|   | 110   | 19889                        | 14                  | 74         | 19999      |
|   | 120   | 19879                        | 14                  | 74         | 19999      |

## COLLIERS EN « V »

| Électrozingués | Inox 304 L | Valeurs (mm)   |           |        |        |     |    |      |
|----------------|------------|----------------|-----------|--------|--------|-----|----|------|
|                |            | Réf. HOBI      | Réf. HOBI | Dia. A | Dia. D | C   | E  | F    |
|                |            | -              | 44592     | 73     | 54     | 8   | 18 | 18   |
|                |            | -              | 55548     | 82     | 63,5   | 4   | 20 | 17   |
|                |            | -              | 22593     | 102    | 76,1   | 7   | 20 | 23,5 |
|                |            | -              | 05519     | 113    | 88,9   | 7   | 20 | 23,5 |
|                |            | -              | 78513     | 113    | 88,9   | 11  | 19 | 21   |
|                |            | -              | 09592     | 121    | 101,6  | 7   | 20 | 23,5 |
|                |            | -              | 05596     | 125    | 101,6  | 5   | 20 | 23,5 |
|                |            | 59189          | -         | 125    | 101,6  | 5   | 20 | 25   |
|                |            | -              | 28566     | 124    | 101,6  | 4   | 20 | 17   |
|                |            | -              | 05583     | 137    | 114,3  | 7   | 20 | 23   |
|                |            | -              | 45563     | 132    | 114,3  | 6   | 20 | 13,5 |
|                |            | -              | 21161     | 142    | 114,3  | 9   | 25 | 18   |
|                |            | -              | 78514     | 134    | 114,3  | 8,5 | 25 | 22   |
|                |            | 71594          | -         | 138    | 120    | 7   | 25 | 17   |
|                |            | Remplace 59185 | 05575     | 151    | 127    | 7   | 20 | 23,5 |
|                |            | 59178          | -         | 151    | 127    | 7   | 25 | 18   |
|                |            | -              | 45535     | 146    | 127    | 6   | 20 | 13,5 |
|                |            | -              | 78539     | 151    | 127    | 4   | 20 | 17   |
|                |            | -              | 78593     | 150    | 127    | 9   | 25 | 23   |
|                |            | -              | 75193     | 159    | 130    | 9   | 25 | 23   |

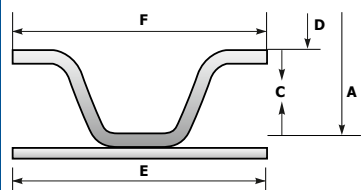

## COLLIERS « SCANIA »

Électrozingués

| Réf. HOBI | Dia. (mm) | Réf. SCANIA      |
|-----------|-----------|------------------|
| 45585     | 114 - 119 | 328928 - 1384745 |
| 45581     | 119 - 124 | 1300367          |

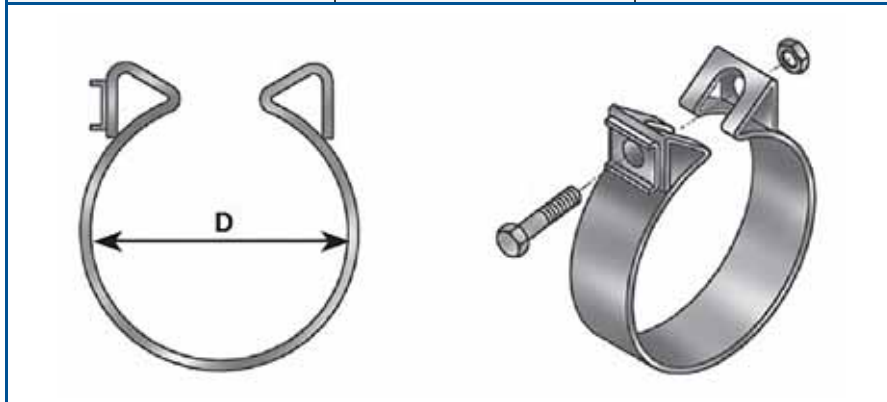

## EMBOUTS 42180 À SOUDER

Électrozingués

| Réf. HOBI Collier | Réf. HOBI Partie Mâle | Dia. Int. (mm) | Réf. HOBI Partie Femelle | Dia. Int. (mm) |
|-------------------|-----------------------|----------------|--------------------------|----------------|
| 42180             | 43115                 | 108            | 43111                    | 108            |

Partie mâle Réf : 43115

42180  
50.01.838.015

Partie Femelle Réf : 43111

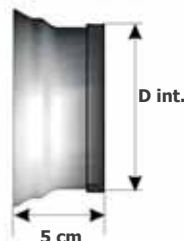
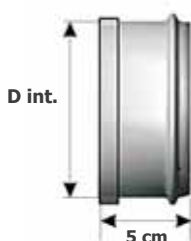

## COUDES à 90° FEMELLE - MÂLE

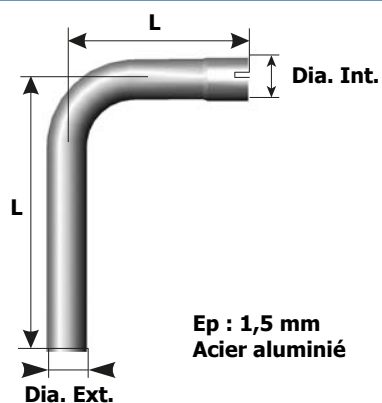

| Réf. HOBI | L : (mm) | Dia. Int. (mm) | Dia. Ext. (mm) |
|-----------|----------|----------------|----------------|
| 18938     | 195      | 51,30          | 50,00          |
| 18930     | 240      | 57,60          | 57,10          |
| 18949     | 240      | 60,50          | 60,00          |
| 18942     | 265      | 64,00          | 63,50          |
| 18944     | 265      | 65,50          | 65,00          |
| 18909     | 270      | 70,30          | 70,00          |
| 18902     | 290      | 75,50          | 75,00          |
| 18904     | 295      | 76,70          | 76,20          |
| 18951     | 320      | 89,40          | 88,90          |
| 18897     | 380      | 102,10         | 101,60         |
| 18895     | 400      | 108,50         | 108,00         |
| 18889     | 400      | 110,50         | 110,00         |
| 18882     | 390      | 114,80         | 114,30         |
| 18878     | 410      | 121,00         | 120,00         |
| 18875     | 415      | 128,00         | 127,00         |
| 18827     | 375      | 141,00         | 140,00         |

## COUDES à 90° MÂLE - MÂLE

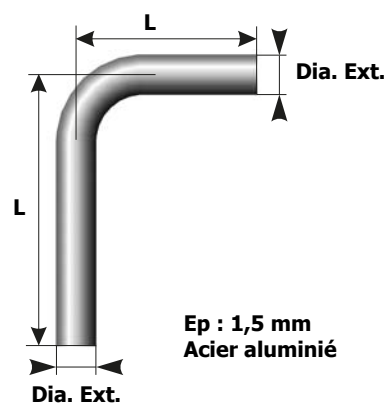

| Réf. HOBI | L : (mm) | Dia. Ext. (mm) |
|-----------|----------|----------------|
| 18939     | 190      | 50,00          |
| 18934     | 240      | 57,10          |
| 18931     | 240      | 60,00          |
| 18946     | 265      | 63,50          |
| 18943     | 265      | 65,00          |
| 18908     | 270      | 70,00          |
| 18906     | 290      | 75,00          |
| 18903     | 295      | 76,20          |
| 18959     | 205      | 80,00          |
| 18955     | 320      | 88,90          |
| 18899     | 380      | 100,00         |
| 18898     | 380      | 101,60         |
| 18891     | 400      | 110,00         |
| 18886     | 390      | 114,30         |
| 18879     | 410      | 120,00         |
| 18870     | 415      | 127,00         |
| 18829     | 375      | 140,00         |

## COUDES à 45° FEMELLE - MÂLE

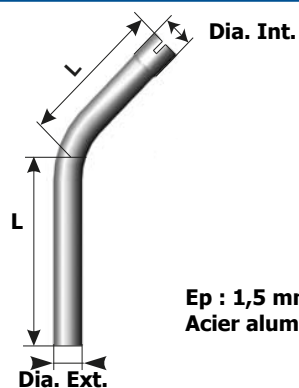

| Réf. HOBI | L (mm) | Dia. Int. (mm) | Dia. Ext. (mm) |
|-----------|--------|----------------|----------------|
| 17938     | 140    | 51,30          | 50,00          |
| 17930     | 150    | 57,60          | 57,10          |
| 17949     | 150    | 60,50          | 60,00          |
| 17942     | 180    | 64,00          | 63,50          |
| 17944     | 180    | 65,50          | 65,00          |
| 17909     | 205    | 70,30          | 70,00          |
| 17902     | 230    | 75,50          | 75,00          |
| 17904     | 205    | 76,70          | 76,20          |
| 17951     | 225    | 89,40          | 88,90          |
| 17897     | 245    | 102,10         | 101,60         |
| 17895     | 260    | 108,50         | 108,00         |
| 17889     | 260    | 110,50         | 110,00         |
| 17882     | 260    | 114,80         | 114,30         |
| 17878     | 365    | 121,00         | 120,00         |
| 17875     | 365    | 128,00         | 127,00         |
| 17829     | 423    | 141,50         | 140,00         |

## COUDES à 45° MÂLE - MÂLE

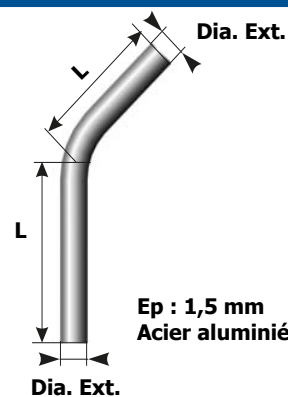

| Réf. HOBI | L (mm) | Dia. Ext. (mm) |
|-----------|--------|----------------|
| 17939     | 140    | 50,00          |
| 17934     | 150    | 57,10          |
| 17931     | 150    | 60,00          |
| 17947     | 180    | 63,50          |
| 17943     | 180    | 65,00          |
| 17908     | 205    | 70,00          |
| 17903     | 230    | 76,20          |
| 17959     | 230    | 80,00          |
| 17955     | 225    | 88,90          |
| 17899     | 245    | 100,00         |
| 17898     | 245    | 101,60         |
| 17891     | 260    | 110,00         |
| 17886     | 260    | 114,30         |
| 17879     | 365    | 120,00         |
| 17870     | 365    | 127,00         |
| 17828     | 423    | 140,00         |



## TUBES DROITS MÂLE - MÂLE

Dia.  
Ext.

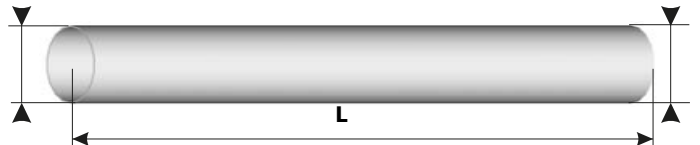

Dia.  
Ext.

Ep : 1,5 mm  
Acier aluminé

| Réf. HOBI | L (m) | Dia. Ext. (mm) |
|-----------|-------|----------------|
| 16039     | 2     | 50,00          |
| 16648     | 2     | 60,00          |
| 16642     | 2     | 63,50          |
| 16644     | 2     | 65,00          |
| 16608     | 2     | 70,00          |
| 12002     | 2     | 75,00          |
| 12003     | 2     | 76,00          |
| 12059     | 2     | 80,00          |
| 12019     | 2     | 88,90          |
| 12099     | 2     | 100,00         |
| 12096     | 2     | 101,60         |
| 12089     | 2     | 110,00         |
| 12083     | 2     | 114,30         |
| 12079     | 2     | 120,00         |
| 12070     | 2     | 127,00         |
| 12029     | 2     | 140,00         |
| 12039     | 2     | 150,00         |

## TUBES FLEXIBLES 2 MÈTRES

Vendus par Longueur de 2 mètres  
Pour avoir le diamètre extérieur ajouter 4 mm au diamètre intérieur

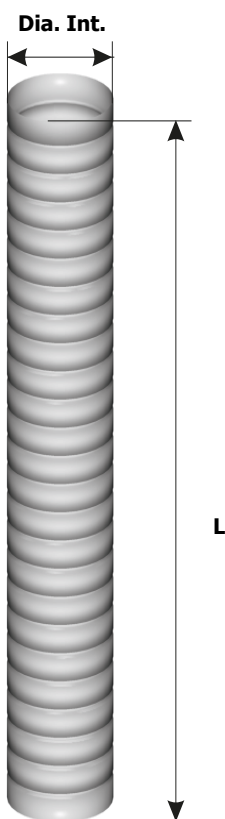

L = longueur du tube comprimé

Remarque : un flexible se monte souple  
(ni tendu - ni comprimé).

| Flex. INOX |                | Flex. Électrozingués |                |
|------------|----------------|----------------------|----------------|
| Réf. HOBI  | Dia. Int. (mm) | Réf. HOBI            | Dia. Int. (mm) |
| 12773      | 25,00          | 13773                | 25,00          |
| -          | 30,00          | 13775                | 30,00          |
| 12767      | 32,00          | 13767                | 32,00          |
| -          | 36,00          | 13763                | 36,00          |
| 12765      | 39,00          | 13765                | 39,00          |
| 12728      | 42,00          | 13728                | 42,00          |
| 12722      | 45,00          | 13722                | 45,00          |
| -          | 48,00          | 13725                | 48,00          |
| 12738      | 51,00          | 13738                | 51,00          |
| 12732      | 54,50          | 13732                | 54,50          |
| 12730      | 58,00          | 13730                | 58,00          |
| 12749      | 61,00          | 13749                | 61,00          |
| 12742      | 64,00          | 13742                | 64,00          |
| 12743      | 66,00          | -                    | 66,00          |
| 12709      | 70,00          | 13709                | 70,00          |
| 12704      | 77,00          | 13704                | 77,00          |
| 12759      | 80,00          | 13759                | 80,00          |
| -          | 83,00          | 13756                | 83,00          |
| 12753      | 86,00          | 13753                | 86,00          |
| 12751      | 90,00          | 13751                | 90,00          |
| -          | 95,00          | 13713                | 95,00          |
| 12799      | 101,00         | 13799                | 101,00         |
| 12797      | 103,00         | 13797                | 103,00         |
| 12792      | 104,00         | 13792                | 104,00         |
| 12795      | 108,00         | 13795                | 108,00         |
| 12789      | 111,00         | 13789                | 111,00         |
| 12782      | 115,00         | 13782                | 115,00         |
| 12779      | 121,50         | 13779                | 121,50         |
| 12774      | 126,50         | 13774                | 126,50         |
| 12770      | 128,00         | 13770                | 128,00         |
| 12768      | 131,50         | 13768                | 131,50         |
| 12729      | 141,00         | 13729                | 141,00         |
| 12737      | 153,50         | 13737                | 153,50         |

## TUBES DROITS MÂLE - FEMELLE

|  | Réf. HOBI                            | L (m) | Dia. Int. (mm) | Dia. Ext. (mm) |
|---|--------------------------------------|-------|----------------|----------------|
|   | <p>Ep : 1,5 mm<br/>Acier aluminé</p> | 16838 | 1,5            | 51,30          |
| 16830   |                                      | 1,5   | 57,60          | 57,10          |
| 16849   |                                      | 1,5   | 60,50          | 60,00          |
| 16842   |                                      | 1,5   | 64,00          | 63,50          |
| 16809   |                                      | 1,5   | 70,30          | 69,80          |
| 16804   |                                      | 1,5   | 76,70          | 76,20          |
| 16851   |                                      | 1,5   | 89,40          | 88,90          |
| 16897   |                                      | 1,5   | 102,10         | 101,60         |
| 16895   |                                      | 1,5   | 108,50         | 108,00         |
| 16889   |                                      | 1,5   | 111,00         | 110,00         |
| 16882   |                                      | 1,5   | 114,80         | 114,30         |
| 16879   |                                      | 1,5   | 121,00         | 120,00         |
| 16870   |                                      | 1,5   | 128,00         | 127,00         |

## TUBES FLEXIBLES 1 MÈTRE

Vendus par Longueur de 1 mètre  
Pour avoir le diamètre extérieur ajouter 4 mm au diamètre intérieur

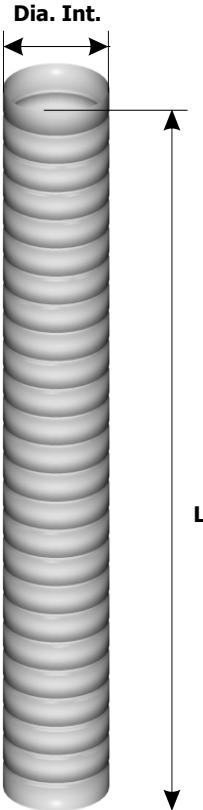
|                           | Flex. INOX |                | Flex. ÉLECTROZINGUÉS |                |
|--|------------|----------------|----------------------|----------------|
|  | Réf. HOBI  | Dia. Int. (mm) | Réf. HOBI            | Dia. Int. (mm) |
| <p>L = longueur du tube comprimé</p> <p>Remarque : Un flexible se monte souple (ni tendu - ni comprimé).</p> | 12873      | 25,00          | 13873                | 25,00          |
|  | -          | 30,00          | 13875                | 30,00          |
|  | 12867      | 32,00          | 13867                | 32,00          |
|  | 12863      | 36,00          | 13863                | 36,00          |
|  | 12865      | 39,00          | 13865                | 39,00          |
|  | 12828      | 42,00          | 13828                | 42,00          |
|  | 12822      | 45,00          | 13822                | 45,00          |
|  | 12825      | 48,00          | 13825                | 48,00          |
|  | 12838      | 51,00          | 13838                | 51,00          |
|  | 12832      | 54,50          | 13832                | 54,50          |
|  | 12830      | 58,00          | 13830                | 58,00          |
|  | 12849      | 61,00          | 13849                | 61,00          |
|  | 12842      | 64,00          | 13842                | 64,00          |
|  | 12840      | 67,00          | 13840                | 67,00          |
|  | 12809      | 70,00          | 13809                | 70,00          |
|  | 12804      | 77,00          | 13804                | 77,00          |
|  | 12859      | 80,00          | 13859                | 80,00          |
|  | -          | 83,00          | 13856                | 83,00          |
|  | 12853      | 86,00          | 13853                | 86,00          |
|  | 12851      | 90,00          | 13851                | 90,00          |
|  | -          | 95,00          | 13813                | 95,00          |
|  | 12899      | 101,00         | 13899                | 101,00         |
|  | 12897      | 103,00         | 13897                | 103,00         |
|  | 12892      | 104,00         | 13892                | 104,00         |
|  | 12895      | 108,00         | 13895                | 108,00         |
|  | 12889      | 111,00         | 13889                | 111,00         |
|  | 12882      | 115,00         | 13882                | 115,00         |
|  | 12879      | 121,00         | 13879                | 121,50         |
| 12874  | 126,50     | 13874          | 126,50               |                |
| 12870  | 128,00     | 13870          | 128,00               |                |
| 12868  | 131,50     | 13868          | 131,50               |                |
| 12829  | 141,00     | 13829          | 141,00               |                |
| 12837  | 153,50     | 13837          | 153,50               |                |

## TUBES COUDÉS



Ep : 1,5 mm  
Acier aluminé

| Réf. HOBI | L (mm) | Dia. int. (mm) |
|-----------|--------|----------------|
| 18239     | 260    | 50,50          |
| 18249     | 305    | 60,50          |
| 18243     | 1500   | 65,50          |
| 18209     | 300    | 70,50          |
| 18203     | 365    | 75,50          |
| 51411     | 1130   | 76,00          |
| 18259     | 340    | 80,50          |
| 18218     | 360    | 90,50          |
| 18298     | 375    | 101,00         |
| 18287     | 535    | 111,00         |
| 59443     | 535    | 115,00         |
| 18278     | 515    | 121,00         |
| 18268     | 500    | 128,00         |

## MANCHONS ACCOUPLEMENTS Dia. Int. / Int.

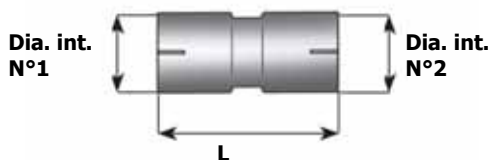

| Réf. HOBI | Dia. N°1 (mm) | Dia. N°2 (mm) | L (mm) |
|-----------|---------------|---------------|--------|
| 16037     | 51,0          | 51,0          | 200    |
| 16038     | 51,0          | 60,5          | 200    |
| 16049     | 60,5          | 64,0          | 200    |
| 16048     | 60,5          | 70,5          | 200    |
| 16047     | 60,5          | 76,7          | 200    |
| 16031     | 61,0          | 61,0          | 200    |
| 16042     | 64,5          | 70,8          | 200    |
| 16043     | 66,0          | 66,0          | 200    |
| 16009     | 70,5          | 76,7          | 200    |
| 16008     | 71,0          | 71,0          | 200    |
| 16002     | 75,5          | 90,5          | 200    |
| 16006     | 76,0          | 76,0          | 250    |
| 16004     | 76,7          | 89,5          | 200    |
| 16000     | 76,7          | 102,1         | 200    |
| 16058     | 77,0          | 77,0          | 250    |
| 16059     | 80,5          | 89,5          | 200    |
| 16007     | 80,5          | 102,1         | 200    |
| 16001     | 81,0          | 81,0          | 250    |
| 16051     | 89,4          | 102,1         | 200    |
| 16018     | 89,4          | 108,5         | 200    |
| 16017     | 89,4          | 110,5         | 200    |
| 16016     | 89,4          | 114,8         | 200    |
| 16055     | 90,0          | 90,0          | 250    |
| 16012     | 90,5          | 114,8         | 200    |
| 16052     | 101,0         | 101,0         | 300    |
| 16011     | 101,0         | 103,0         | 200    |
| 16099     | 101,0         | 114,8         | 200    |
| 16097     | 102,1         | 109,0         | 200    |
| 16092     | 102,1         | 110,5         | 200    |
| 16086     | 102,1         | 114,8         | 200    |
| 16093     | 102,1         | 127,5         | 200    |
| 16094     | 103,0         | 103,0         | 300    |
| 16091     | 108,5         | 110,5         | 200    |
| 16095     | 108,5         | 114,8         | 200    |
| 16088     | 108,5         | 120,5         | 200    |

## SUITE...

| Réf. HOBI | Dia. N°1 (mm) | Dia. N°2 (mm) | L (mm) |
|-----------|---------------|---------------|--------|
| 16087     | 108,5         | 127,5         | 200    |
| 16084     | 110,5         | 114,8         | 200    |
| 16080     | 110,5         | 120,5         | 200    |
| 16085     | 110,5         | 127,5         | 200    |
| 16054     | 111,0         | 111,0         | 300    |
| 16081     | 114,8         | 127,5         | 200    |
| 16073     | 115,0         | 115,0         | 300    |
| 16079     | 120,5         | 127,5         | 200    |
| 16072     | 128,0         | 128,0         | 200    |

## MANCHONS / ACCOUPLEMENTS Dia. Int. / Ext.

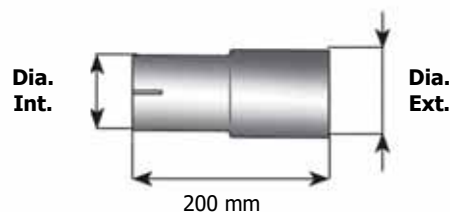

| Réf. HOBI | Dia. Int. (mm) | Dia. Ext. (mm) | L (mm) |
|-----------|----------------|----------------|--------|
| 16046     | 64,5           | 70,0           | 200    |
| 16041     | 70,8           | 76,2           | 200    |
| 16003     | 76,7           | 88,9           | 200    |
| 16053     | 76,7           | 101,6          | 200    |
| 16005     | 89,4           | 101,6          | 200    |
| 16082     | 102,1          | 114,3          | 200    |
| 16773     | 102,1          | 127,0          | 200    |
| 16071     | 114,8          | 127,0          | 200    |

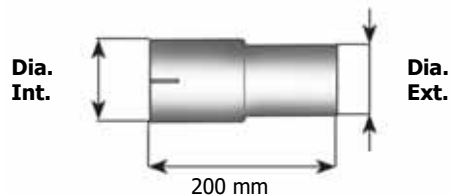

| Réf. HOBI | Dia. Int. (mm) | Dia. Ext. (mm) | L (mm) |
|-----------|----------------|----------------|--------|
| 16019     | 89,4           | 76,2           | 200    |
| 16056     | 102,1          | 76,2           | 200    |
| 16096     | 102,1          | 88,9           | 200    |
| 16089     | 110,5          | 101,6          | 200    |
| 16083     | 114,8          | 101,6          | 200    |
| 16077     | 128,0          | 101,6          | 200    |

## CAOUTCHOUCS

M 8

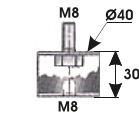

**21190**  
81.96210.052

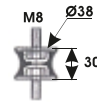

**78577**  
0285530

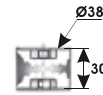

**75560**  
98415197

M 10

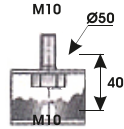

**21565**  
81.96210.0101

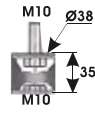

**39139**  
697.987.0139

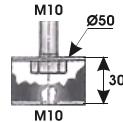

**21189**  
81.96210.0153

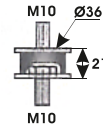

**39189**  
001.987.5340

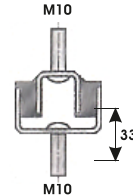

**41592**  
4.771.333.000

M 12



**59121**  
324842

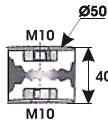

**59138**  
1580440

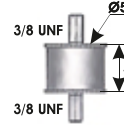

**09590**  
36233 SI

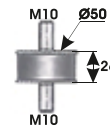

**72196**  
104939-8

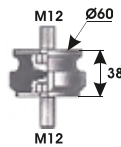

**78579**  
0221342

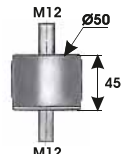

**59139**  
6850149

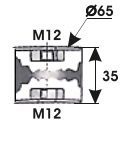

**45199**  
40607

UNIVERSEL

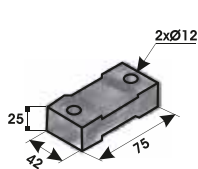

**39187**  
667.490.0037

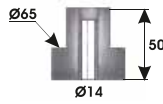

**72197**  
100348-3

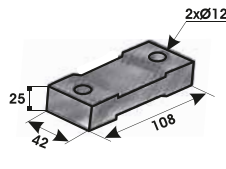

**39192**  
309.490.0037



**72192**  
117280-3

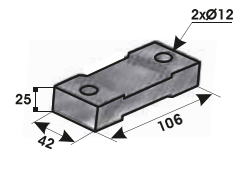

**78575**  
0298390

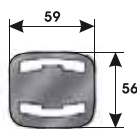

**39591**  
381.492.0082

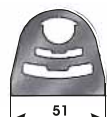

**39153**  
901.492.0044

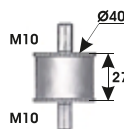

**42592**  
5000750531

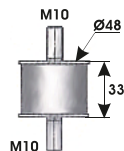

**42580**  
5000750630

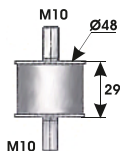

**41580**  
4.771.244.000

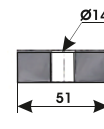

**42598**  
0000689778



**42574**  
5000750518

# PARE FLAMMES « PL » (Poids Lourds)



Dia. Int.

### Livré avec :

- Une grille triple épaisseur
- Une grille simple épaisseur
- Un collier à tourillons
- Des bagues de réduction
- Un emballage carton

| Réf. HOBI | Dia. Int. (mm) |
|-----------|----------------|
| 29594 (*) | 45,5 - 50,5    |
| 29590     | 55,5           |
| 29595     | 60,5           |
| 29591     | 65,5           |
| 29589     | 70,5           |
| 29588     | 75,5           |
| 29587     | 80,5           |
| 29586     | 85,5           |
| 29582     | 90,5           |
| 29583     | 95,5           |
| 29584     | 101            |
| 29580     | 106            |
| 29585     | 111            |
| 29581     | 116            |
| 29579     | 121 - 126      |
| 29578     | 131 - 136      |

| (*) ADAPTATEUR |                |                |
|----------------|----------------|----------------|
|                |                |                |
| Réf. HOBI      | Dia. Ext. (mm) | Dia. Int. (mm) |
| 29576          | 50             | 45,5           |

# PARE FLAMMES « VL » (Véhicules Légers)



Dia. Int.

### Livré avec :

- Une grille triple épaisseur
- Une grille simple épaisseur
- Un collier à tourillons
- Des bagues de réduction
- Un emballage carton

| Réf. HOBI | Dia. Int. (mm) |
|-----------|----------------|
| 29599     | 32,5 - 39,0    |
| 29598     | 39,5 - 44,0    |
| 29597     | 44,5 - 49,0    |
| 29596     | 49,5 - 54,0    |
| 29592     | 54,5 - 59,0    |

| KIT Réparation Pare-Flammes : PL |                           |                           |
|----------------------------------|---------------------------|---------------------------|
| 1 grille triple épaisseur        | 1 grille simple épaisseur | 3 crochets<br>1 couvercle |
|                                  |                           |                           |
| Réf. HOBI                        | 29577                     |                           |

| KIT Réparation Pare-Flammes : VL |                           |                           |
|----------------------------------|---------------------------|---------------------------|
| 1 grille triple épaisseur        | 1 grille simple épaisseur | 2 crochets<br>1 couvercle |
|                                  |                           |                           |
| Réf. HOBI                        | 29593                     |                           |



## SILENCIEUX STANDARD

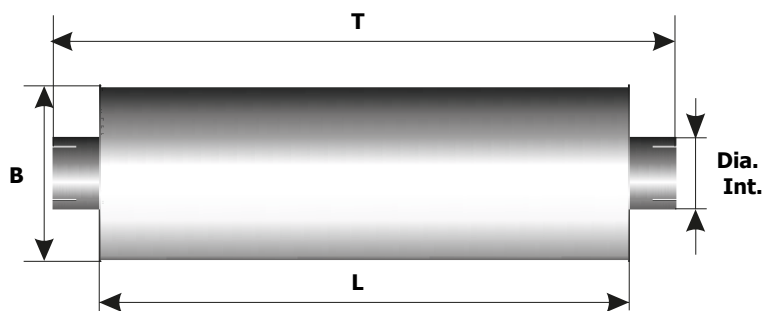

| Réf. HOBI | T (mm) | L (mm) | B (mm) | Dia. Int. (mm) |
|-----------|--------|--------|--------|----------------|
| 50604     | 927    | 800    | 184    | 77             |
| 50651     | 927    | 800    | 184    | 89,50          |
| 50297     | 1145   | 965    | 184    | 102            |
| 50682     | 1219   | 1041   | 249    | 115            |
| 50670     | 1219   | 1041   | 249    | 128            |

## BANDE THERMIQUE



| Réf. HOBI | Longueur (m) | Largeur (mm) | Épaisseur (mm) |
|-----------|--------------|--------------|----------------|
| 11999     | 10           | 100          | 2              |



## RACCORDS à 90° MÂLE - FEMELLE

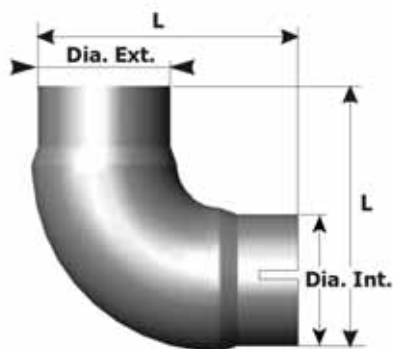

| Réf. HOBI | L (mm) | Dia. Ext. (mm) | Dia. Int. (mm) |
|-----------|--------|----------------|----------------|
| 14938     | 200    | 50,00          | 51,30          |
| 14943     | 200    | 63,50          | 64,00          |
| 14904     | 200    | 76,20          | 78,80          |
| 14951     | 200    | 88,90          | 89,40          |
| 14897     | 200    | 101,60         | 102,10         |
| 14895     | 200    | 108,00         | 108,50         |
| 14882     | 200    | 114,30         | 114,80         |
| 14870     | 200    | 127,00         | 128,00         |

Acier Aluminisé - Épaisseur : 1,5 mm

## RACCORDS à 90° MÂLE - MÂLE

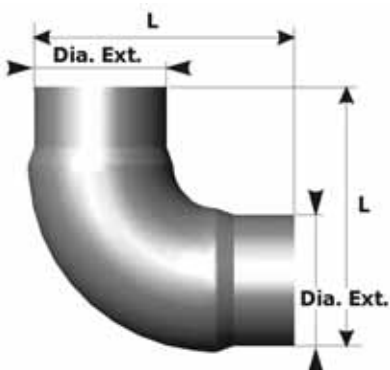

| Réf. HOBI | L (mm) | Dia. Ext. (mm) | Dia. Ext. (mm) |
|-----------|--------|----------------|----------------|
| 14939     | 200    | 50,00          | 50,00          |
| 14942     | 200    | 63,50          | 63,50          |
| 14903     | 200    | 76,20          | 76,20          |
| 14955     | 200    | 88,90          | 88,90          |
| 14898     | 200    | 101,60         | 101,60         |
| 14890     | 200    | 108,00         | 108,00         |
| 14886     | 200    | 114,30         | 114,30         |
| 14874     | 200    | 127,00         | 127,00         |

Acier Aluminisé - Épaisseur : 1,5 mm

## RACCORDS à 90° FEMELLE - FEMELLE

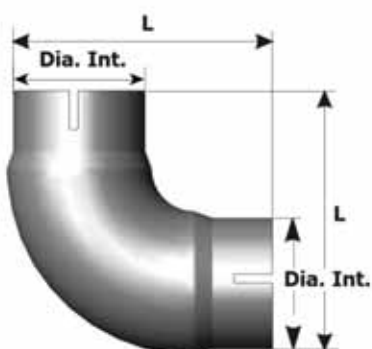

| Réf. HOBI | L (mm) | Dia. Int. (mm) | Dia. Int. (mm) |
|-----------|--------|----------------|----------------|
| 10938     | 200    | 51,30          | 51,30          |
| 10943     | 200    | 63,50          | 63,50          |
| 10904     | 200    | 76,80          | 76,80          |
| 10951     | 200    | 89,40          | 89,40          |
| 10897     | 200    | 102,10         | 102,10         |
| 10895     | 200    | 108,50         | 108,50         |
| 10889     | 200    | 110,50         | 110,50         |
| 10882     | 200    | 114,80         | 114,80         |
| 10870     | 200    | 128,00         | 128,00         |

Acier Aluminisé - Épaisseur : 1,5 mm

## GRILLES PARE-CHALEUR TUBES

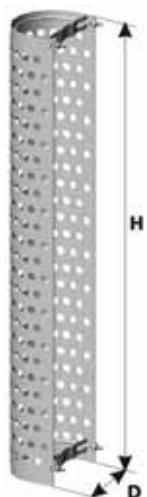

| Réf. HOBI | H (mm) | D (mm) |
|-----------|--------|--------|
| 13339     | 800    | 50     |
| 13349     | 800    | 60     |
| 13309     | 800    | 70     |
| 13303     | 800    | 75     |
| 13357     | 800    | 80     |
| 13351     | 800    | 90     |
| 13396     | 800    | 100    |
| 13389     | 800    | 110    |
| 13382     | 800    | 114    |
| 13378     | 800    | 120    |
| 13375     | 800    | 127    |

Acier Electrozingué

Colliers de fixation fournis - D = Dia. Ext. du tube

## SANGLES POUR SILENCIEUX

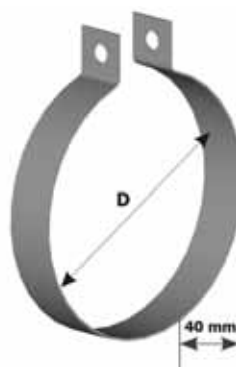

| Réf. HOBI | D (mm) |
|-----------|--------|
| 15037     | 155    |
| 15005     | 178    |
| 15052     | 184    |
| 15096     | 206    |
| 15075     | 228    |
| 15032     | 254    |
| 15001     | 284    |
| 15593     | 300    |
| 75599     | 380    |

Acier Aluminisé

Ép. : 3 mm - D = Dia. Ext. du silencieux

**CHANGEZ POUR HOBI  
ET NE CHANGEZ PLUS**

« *Des silencieux à ce prix là ! Ça va faire du bruit...* »

Silencieux Euro 6

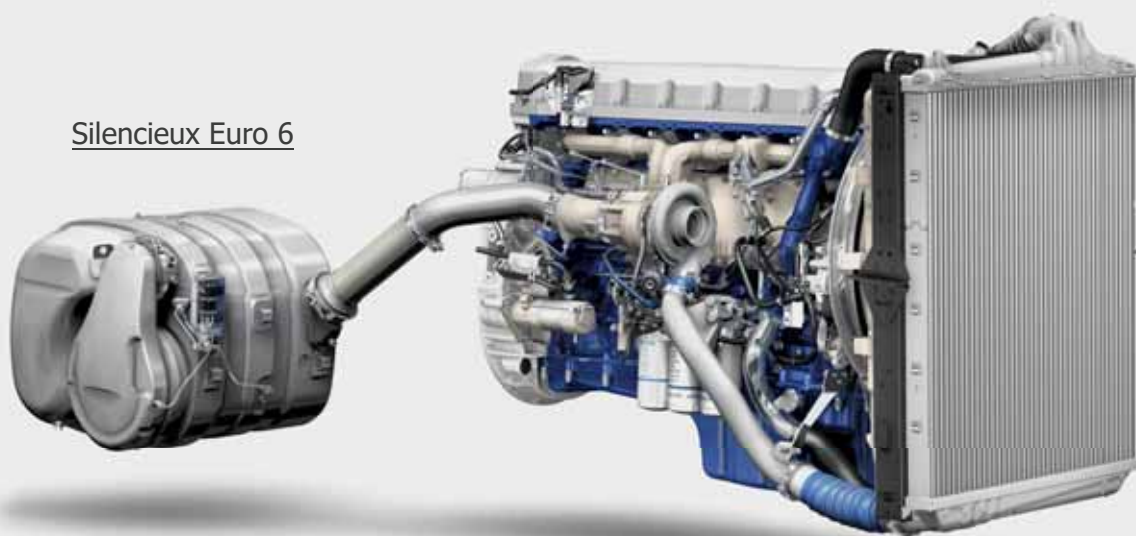

#### **SIÈGE SOCIAL HOBI FRANCE**

9, rue Condorcet - Zone industrielle  
94430 Chennevières-sur-Marne  
Tél. : 00.33.(0)1.56.31.28.32  
Fax : 00.33.(0)1.56.31.28.33  
Email : [hobi@hobifrance.com](mailto:hobi@hobifrance.com)  
Web : [www.hobifrance.com](http://www.hobifrance.com)

Pour : informations techniques, ouverture de comptes, accord de retour pièces, prix etc.

#### **DÉPÔT HOBI FRANCE**

P.A du versant Nord-Est  
16, rue du Trieu du Quesnoy  
59115 LEERS - France  
Tél. : 00.33.(0)3.20.60.33.33  
Fax : 00.33.(0)3.20.95.90.00  
Mail : [cdebarre59@orange.fr](mailto:cdebarre59@orange.fr)  
8h30 - 12h et 14h - 17h30

Pour : commandes, montant d'un port  
Informations sur les livraisons etc.

**hObi**®

ÉCHAPPEMENTS PL  
RÉSERVOIRS D'AIR PL  
RÉSERVOIRS DE CARBURANT PL